

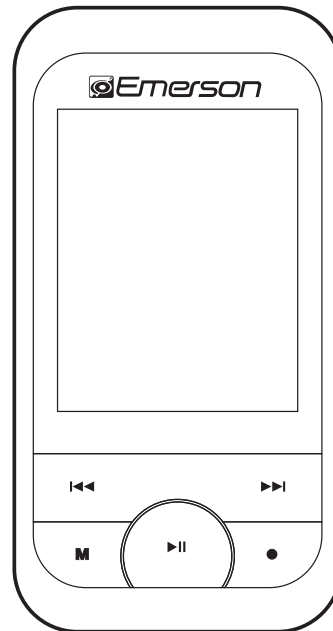

# MP3 Music & Video Player

## User Guide

2 GB



EMP413-2

---

# IN THE BOX

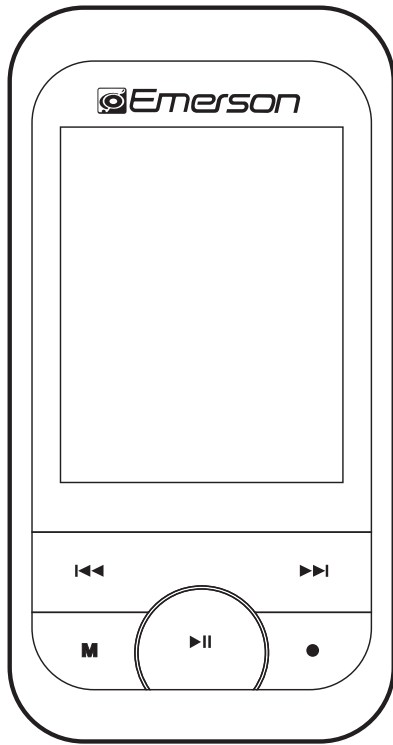

Emerson MP3 Video Player

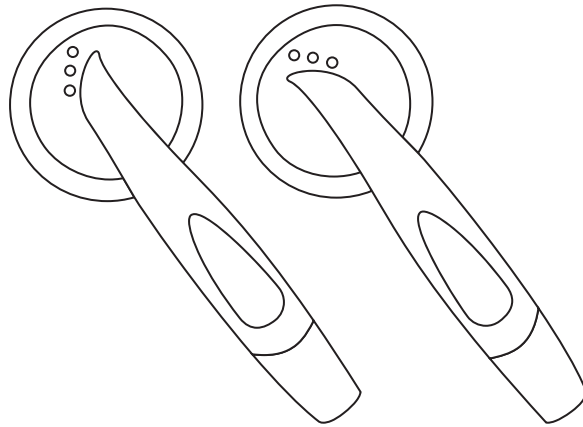

Stereo Headphones

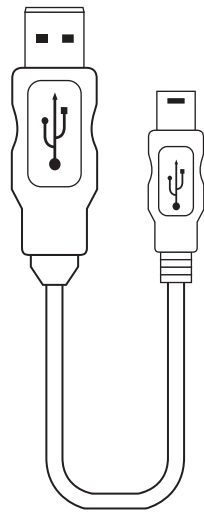

USB 2.0 Cable  
(for battery charging  
and high speed data transfer)



Installation CD

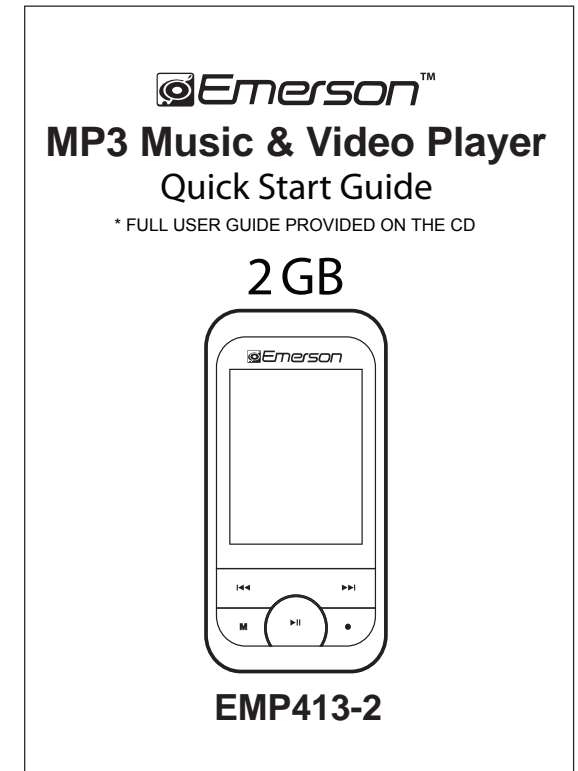

Quick Start Guide

---

 **FCC INFORMATION**

## FCC Part 15

This equipment has been tested and found to comply with the requirements for a Class B digital device under Part 15 of the Federal Communications Commission (FCC) rules. These requirements are intended to provide reasonable protection against harmful interference in a residential installation. This equipment generates, uses and can radiate radio frequency energy and, if not installed and used in accordance with the instructions, may cause harmful interference to radio communications. However, there is no guarantee that interference will not occur in a particular installation. If this equipment does cause harmful interference to radio or television reception, which can be determined by turning the equipment off and on, the user is encouraged to try to correct the interference by one or more of the following measures:

- Re-orient or relocate the receiving antenna.
- Increase the separation between the equipment and receiver.
- Connect the equipment into an outlet on a circuit different from that to which the receiver is connected.
- Consult the dealer or an experienced radio/TV technician for help.

Changes or modifications to this equipment not expressly approved by the party responsible for compliance could void the user's authority to operate the equipment.

---

## INTRODUCTION

Congratulations on purchasing the Emerson MP3 Music & Video Player.

Before using the player, read this manual thoroughly and keep it for future reference.

This manual contains important safety information and correct operation instructions. Read the manual carefully before you use the player in order to avoid any confusion.

### **Copyright Information**

Trademarks and trade names used in this instruction manual are owned by their respective companies or organizations.

Unauthorized duplication of any recordings whether downloaded from the internet or made from audio CDs is a violation of copyright laws and international treaties.

The making of unauthorized copies of copy-protected material, may be an infringement of copyrights and constitute a criminal offence. This equipment should not be used for such purposes.

## IMPORTANT SAFETY PRECAUTIONS

Always follow these basic safety precautions when using your player. This will reduce the risk of product damage and personal injury.

- Do not disassemble, repair or modify the player by yourself. Refer servicing to qualified personnel.
- This device contains a built-in battery, do not dispose of in fire.
- In the event that the battery is leaking, do not handle the device with your bare hands. Contact the service center for help since the liquid may remain in the player. If your body or clothes had contact with the battery liquid, wash it off thoroughly with water. Also, if some liquid gets into your eyes, do not rub your eyes but immediately wash them with clean water, and consult a doctor.
- Keep the player away from direct sunlight and any direct heat source.
- Do not expose the unit to rain or moisture.
- Do not use the player in dry environments to avoid static.
- Never apply heavy impact on the player, or place it on a magnet.
- Route the USB cable so that people and pets are not likely to trip over it.
- Disconnect the USB cable from the computer when you do not use the player for a long time.
- Clean only with a dry cloth. Make sure the player is turned off before cleaning. Do not use a liquid cleanser.
- Be sure to back up your files. We will not be liable for the loss of data due to improper operation, repair or other causes.

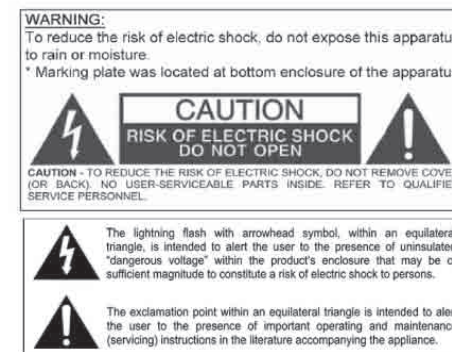

### Precautions in using the earphones

- Do not use the earphones while driving an automobile or riding a bicycle. It is dangerous, and against the law. To avoid an accident, do not turn up the volume of the earphones too high while walking.
- It is not recommended that you use the headphones at a high volume for an extended time, as this may cause hearing damage.

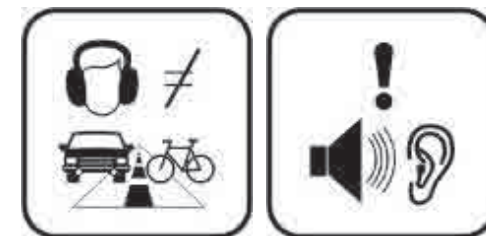

---

 **FEATURES**

- 1.5" color display
- 2 GB internal memory
- USB 2.0 high speed connection
- Stores and plays music, video, and pictures
- Text reading (txt format)
- Digital voice recording (built-in microphone)
- Folder navigation
- Rechargeable battery
- Supports MP3 / WMA / WAV music formats
- Converted video files (includes video converter software)
- JPEG format picture browsing

## LOCATIONS OF CONTROLS

1. [⏮] - **Previous button**: Previous track / Fast backwards / Volume down
2. [M] - **Menu button**: Main menu / Select an option / Back to main menu
3. [▶||] - **Play button**: Power On-Off button / Pause
4. [●] - **VOL button**: Adjust volume
5. [▶▶] - **Next button**: Next track / Fast forward / Volume up
6. Display
7. USB 2.0 Hi-Speed connector for battery charging and data transfer
8. [Reset] - Reset hole
9. Headphone jack

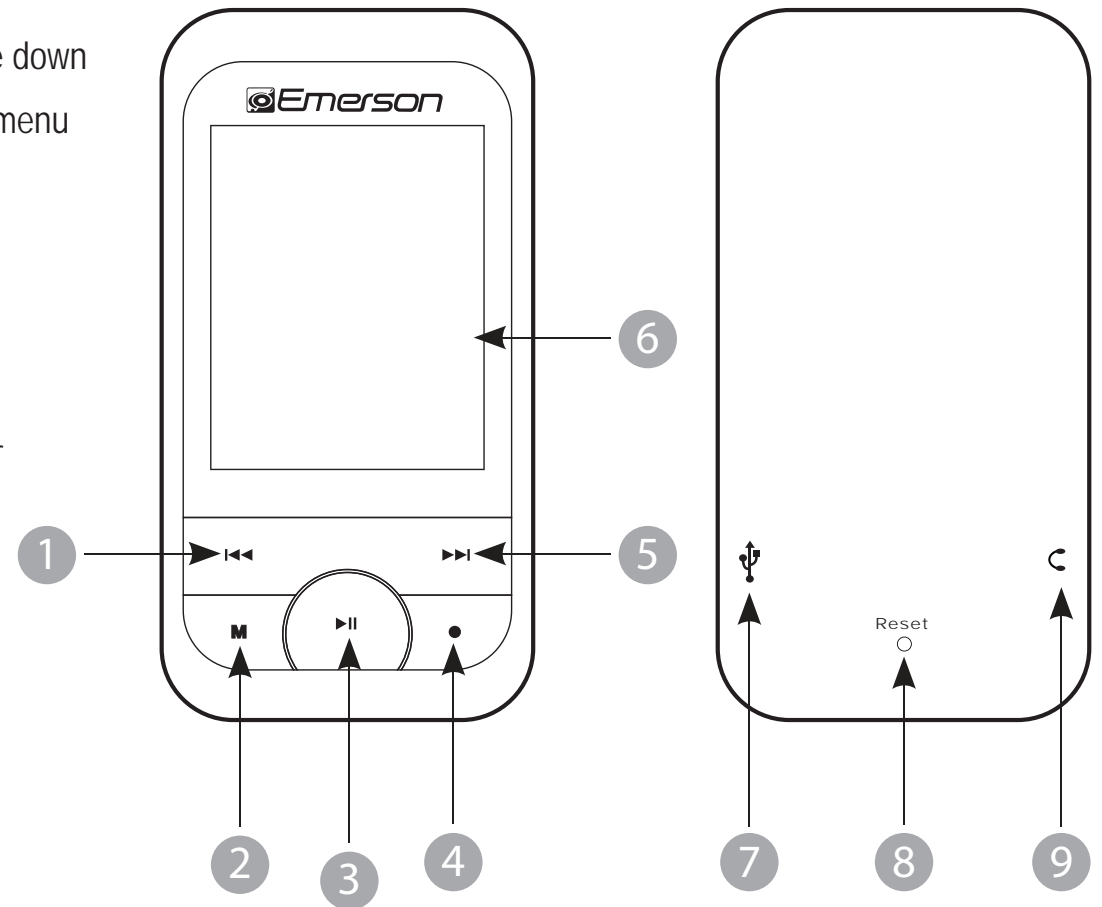

---

## CONNECTING TO A COMPUTER

### System requirements

Your computer system must meet the following specifications:

- Pentium 200MHz or above
- Microsoft Windows 2000/ME/XP/Vista
- USB port supported

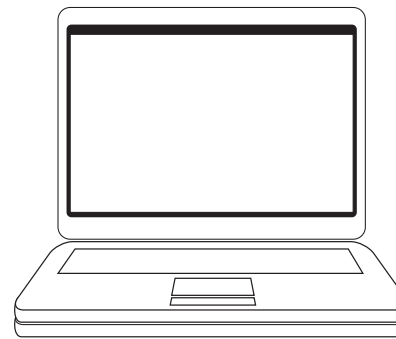

PC

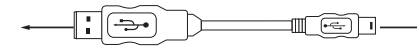

USB High Speed Connection Cable

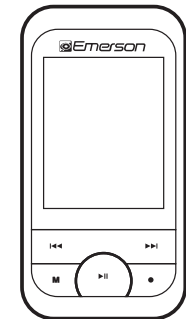

MP3 Player

### PC connection

In order to enjoy the multimedia capabilities of your **MP3 Player**, you have to first copy your favorite files from your PC to its internal memory. Connect your **MP3 Player** to the computer using the included USB 2.0 cable. The device will be detected automatically without installing any driver. Once detected, you can read/write to the device's memory just as if you were using a regular disk drive.

Make sure your computer is powered on, and follow the steps below to connect the player to your computer.

1. Plug the larger USB connector of the USB cable into the USB port on the computer.
2. Plug the other end (small) of the USB cable to the player.
3. The computer system detects "New hardware" and starts to install the driver automatically. Wait for the system to finish the installation.

When it has finished, "**Emerson MP3**" will be created in "**My Computer**".

**Important:** To avoid any data loss, always perform a safe USB device extraction before disconnecting the USB cable from the PC. In Windows XP, for example, you can find the safe extraction icon in the task bar next to the system clock.



---

## Disconnecting the USB cable

After completing the file transfer, please disconnect the USB cable the following way:

1. Double click the green arrow **"Safely Remove Hardware"** in the task bar on the bottom right of the window.
2. Select **"USB Device"** and click **"Stop"**.
3. When the **"Stop a Hardware device"** appears, click **"OK"** to disconnect the USB mass storage device, and unplug the player safely.

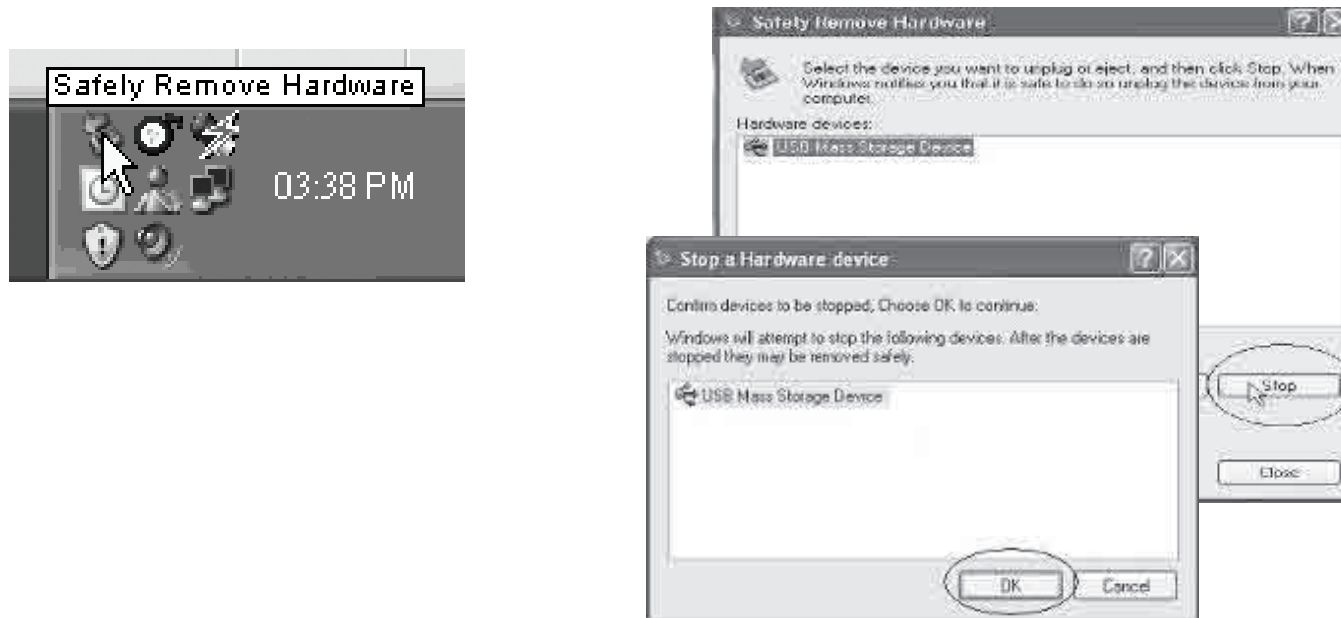

---

## CHARGING THE BATTERY

Your MP3 Player has an integrated rechargeable Li-ion battery. It is recommended to fully charge the player before using it for the first time.

Recharge the battery by connecting the player to a computer using the included USB 2.0 cable.

Charging time is between 3-5 hours, depending if the player is powered off or working. To keep the battery in good condition, we recommend not charging it for more than 8 hours.

### Important:

- *Fully charge it before you use the player for the first time or when you haven't used it for a long time.*
- *Charge the player immediately when the "Low battery" message is displayed.*
- *Do not over charge or discharge the player. Over charging or discharging will shorten the battery life.*
- *The battery could be over discharged if the player is not used for a long time (over three months). To avoid over discharge, fully charge the player every three months and always keep the voltage of the batte*

## BASIC OPERATION

### Turning on/off

- To turn on the player press and HOLD the [▶||] button for 3 seconds until the LCD screen lights up.
- To turn the player off, press and HOLD the [▶||] button until the LCD screen shuts off.

### Adjusting the volume

Press the [●] button then press the [▶▶] button to increase the volume, or press the [◀◀] button to decrease the volume.

### Selecting main menu or mode

- Use the [◀◀] or [▶▶] buttons to select an option from the main menu, and press the [M] button to confirm your selection.
- To return to the main menu, press and HOLD the [M] button.

### Reset

- In the event your MP3 Video Player freezes or is not functioning properly, press the [Reset] button as shown in the diagram at the right.

**NOTE:** Pressing the [Reset] button will not affect the files stored on the player.

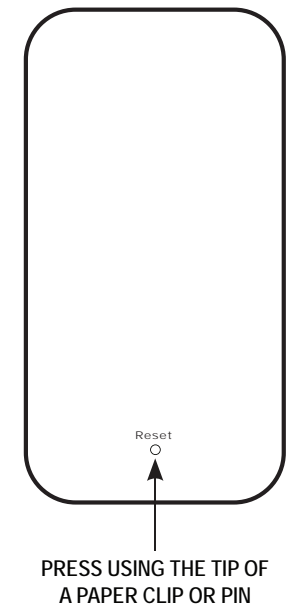
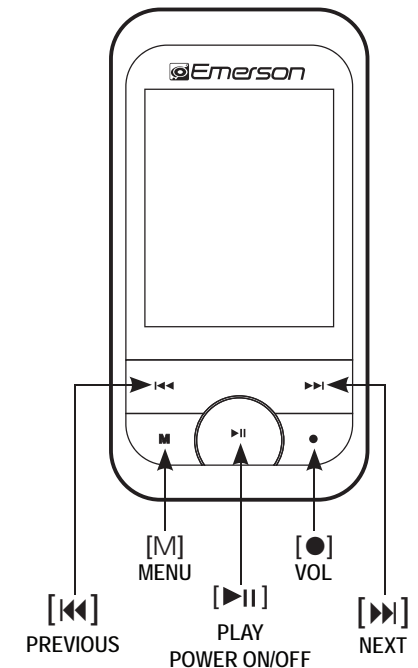

# TRANSFERRING MEDIA FILES TO THE PLAYER

The MP3 Player is capable of storing, displaying, and playing your favorite music, pictures, and video.

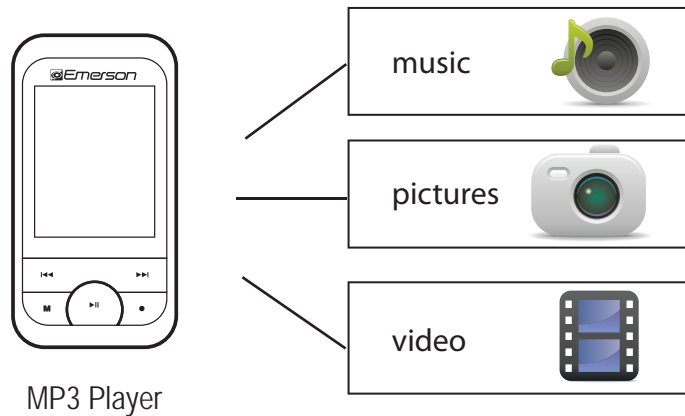

MP3 Player

## Transferring media to the player

To transfer media from your computer, perform the following steps:

1. Connect the MP3 player to the USB port of your computer.
2. Open "Windows Explorer" or "My Computer", and locate "Emerson MP3".
3. Select the files on your computer, and simply move it into "Emerson MP3" in the usual way (drag-and-drop, copy-and-paste). After copying is completed, the data will be available on the MP3 Player.

We recommend using *Windows Media Player* to organize and transfer music, pictures, and videos to your player. For more information regarding *Windows Media Player*, please refer to the *Quick Start and Media Transfer Guide*, or the included CD.

**Note:** Please do not disconnect the USB cable during loading, it may cause malfunction of the player and the files.

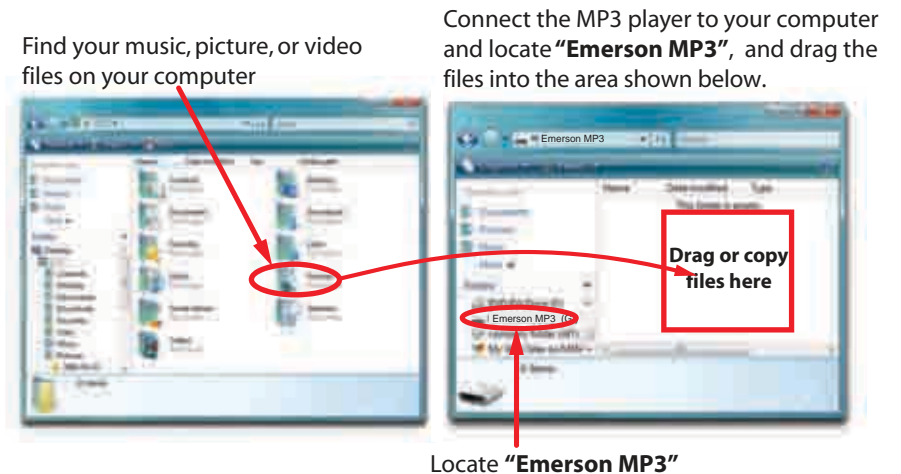

---

## MUSIC

### Using the music player

Select "MUSIC" from the main menu using the [◀◀] or [▶▶] buttons, and press the [M] button to enter.

### Listening to music

1. Use the [◀◀] or [▶▶] buttons to select the music file you wish to listen to and press the [M] or [▶▶] button.
2. While a song is playing, press the [▶▶] button to pause the playback. To resume playback, press the [▶▶] button once again.
3. To return to the main menu, press and **HOLD** the [M] button.

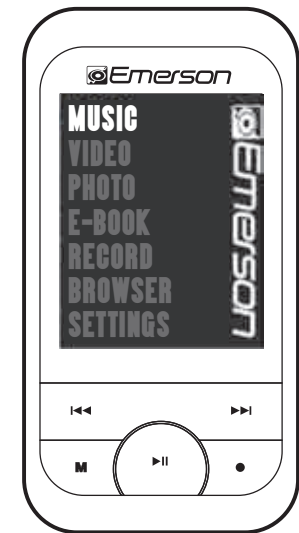

### Adjusting the volume

1. Press the [●] button while playing a song, the "VOL" icon turns red on the music players screen.
2. Press the [◀◀] or [▶▶] button to decrease or increase the volume.
3. Press the [●] button to exit the volume adjusting mode.

---

## Skipping tracks

- Briefly press the [⏮] button to go to the previous track.
- Briefly press the [⏭] button to skip to the next track.

## Searching backward or forward within a track

- Press and **HOLD** the [⏮] button to play backward within a track.
- Press and **HOLD** the [⏭] button to play forward within a track.

## Music player settings

Press the [M] button during music playback to choose from the following options:

- Repeat
- Equalizer
- Tempo rate
- Replay
- Replay times
- Repeat gap
- Music Ebook
- Exit

Use the [⏮] or [⏭] setting to select, and then [M] button to confirm your selections.

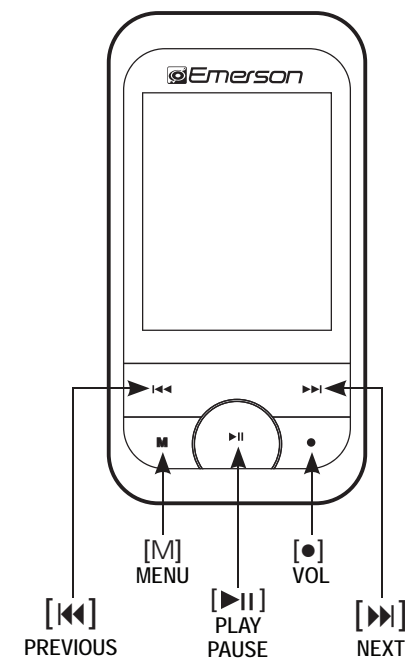

---

## VIDEO

Store and playback videos to watch and enjoy anywhere!

**NOTE:** You must convert a video to the correct format before transferring it to the player.

See “**CONVERTING VIDEOS**” (page 16)

### Playing videos

1. Select “**VIDEO**” from the main menu using the [◀◀] or [▶▶] buttons, and press the [M] button to enter.
2. Use the [◀◀] or [▶▶] buttons to select the video file you would like to watch, and press the [M] button to begin playback.
3. Press the [▶||] button to pause or resume playback..
4. To return to the main menu, press and **HOLD** the [M] button.

### Searching backward or forward

1. Use the [◀◀] or [▶▶] buttons to skip to the previous/next video.
2. To fast forward or rewind a video, press and **HOLD** the [◀◀] or [▶▶] buttons.
3. To return to the main menu, press and **HOLD** the [M] button.

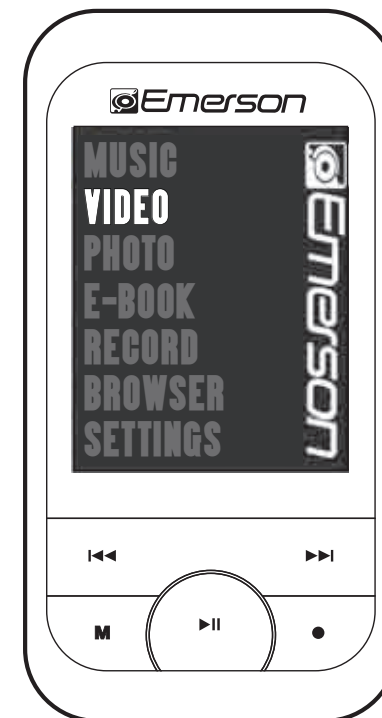

# CREATING AVI VIDEOS

Before transferring video files to the MP3 Player, you must convert them to the correct format.

With the Video Converter software tool you can easily convert your videos to the correct format (128 x 128 resolution) so you can enjoy them on your MP3 Player.

To install the Video Converter on your computer follow the steps below:

1. Insert the provided CD to the CD-ROM drive of your computer, and click on "Video Converter".
2. Click "Install" and then "Next".
3. Follow installation instructions to download the converter to your computer.



Click on "Video Converter"



Click "Install"



Click "Next"

4. Click "Install" when you see the screen below, and then click "Finish".



Click "Install"



Click "Finish"

5. Click the  icon on your "Desktop" to open the Video Converter.



## Converting videos

1. Connect the MP3 Player to the USB port of your computer (optional).
2. Click on "MP4Tool" from the "Start" menu, or the  icon on your desktop.
3. Click on the "Configurations" drop down window, and then "Advanced configuration".
4. Click on the "VideoSize" drop down window and select "128 x 128" resolution.
5. Click "Save", and then click "Exit".

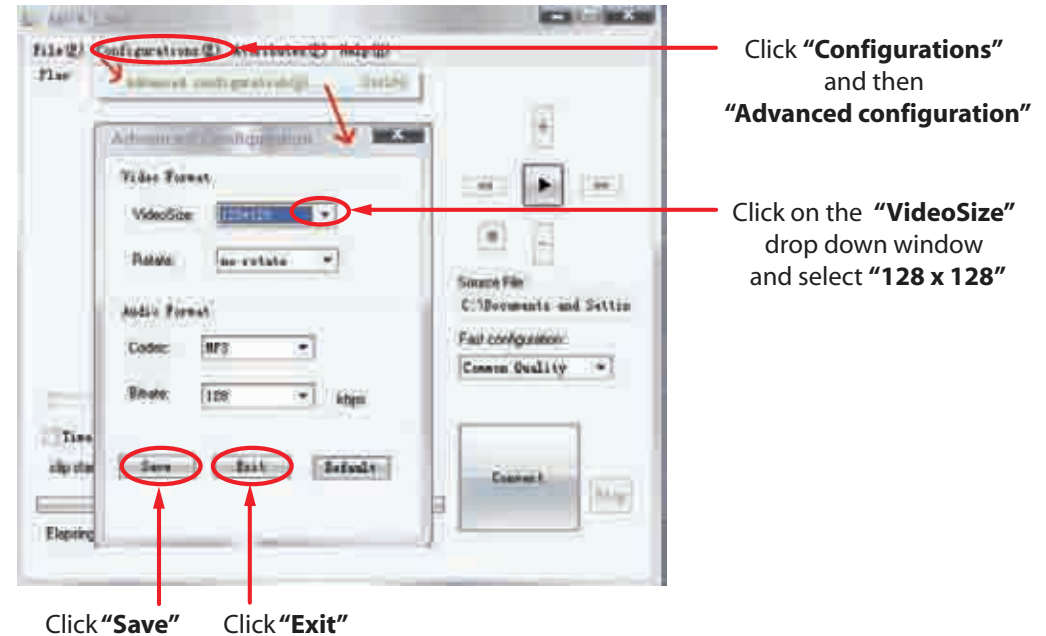
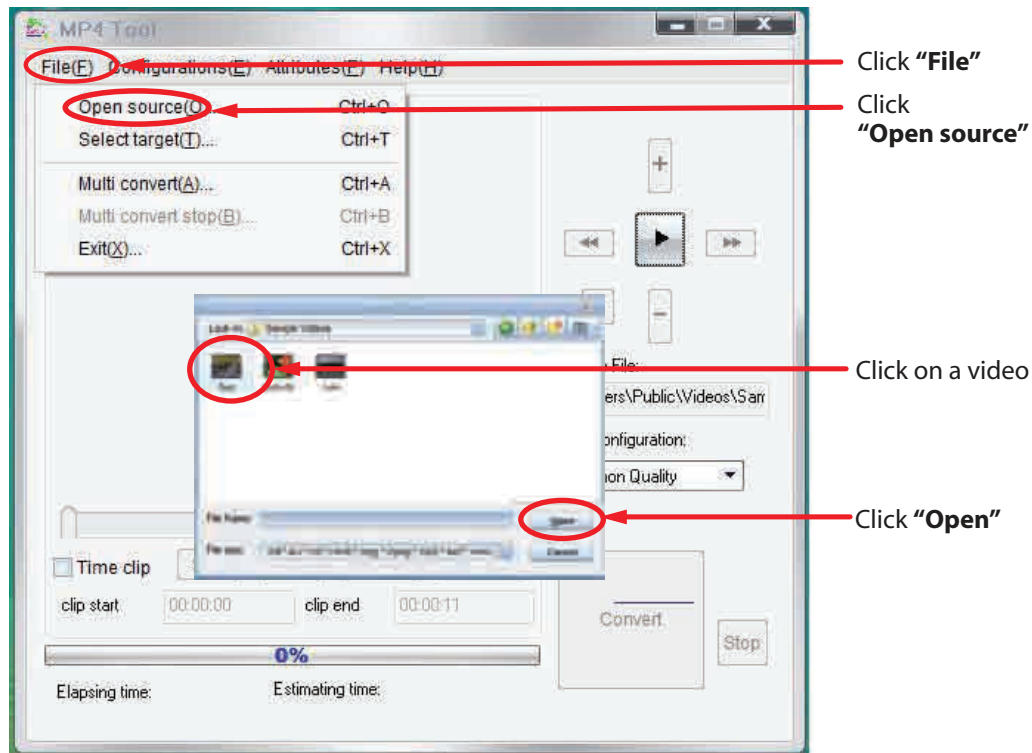

6. Click "File" and then "Open source" to find and select the video you would like to convert.
7. Click on a video and then click "Open".

## Converting videos

8. Click on **"File"** and then **"Select target"** to select the destination for the converted video. You can send it directly to your player by selecting **"Emerson MP3"**, and clicking **"OK"**, or if you would like to save the video to your computer, we recommend sending it to your **"Desktop"** where you can easily find the video, and transfer it to your player. (See **"TRANSFERRING MEDIA FILES TO THE PLAYER"** on page 11)

**NOTE:** To send a converted video directly to your player, it must be connected to the computer's USB port at time of conversion.

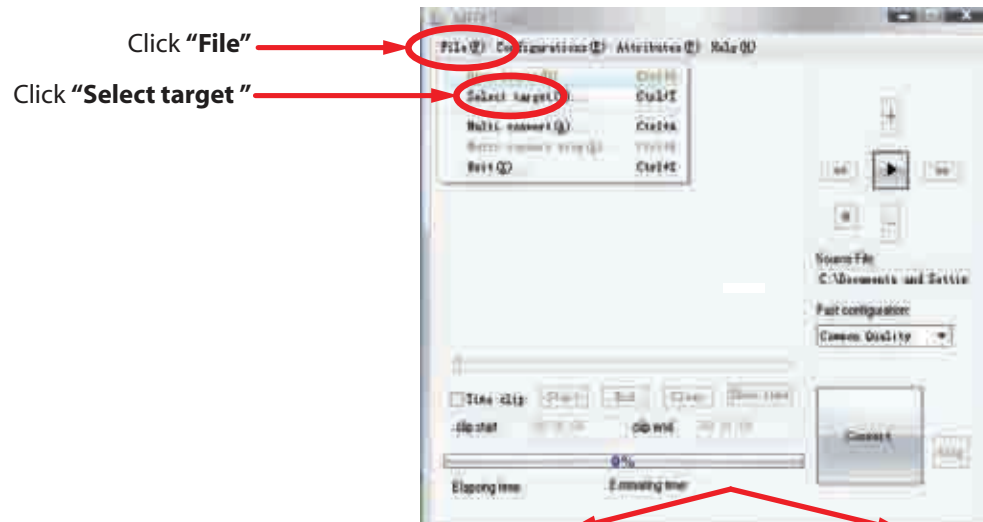

Choose **"Desktop"** and save the converted video to the **"Desktop"** on your computer. After saving the converted video to your desktop, you can transfer it directly to your player. See **"TRANSFERRING MEDIA FILES TO THE PLAYER"** (page 11).

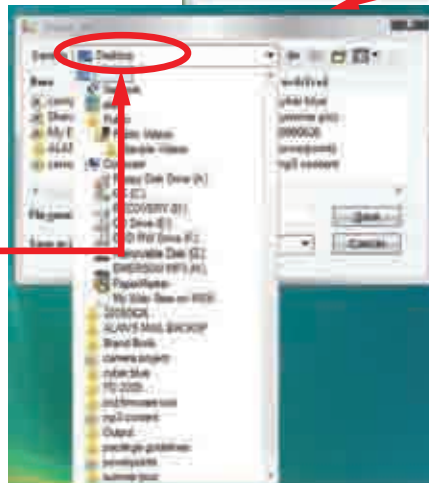

OR

Choose **"Emerson MP3"** and save the converted video directly to your MP3 Player.

**Note:** Your MP3 Player must be connected to the USB port of your computer during the conversion for this option.

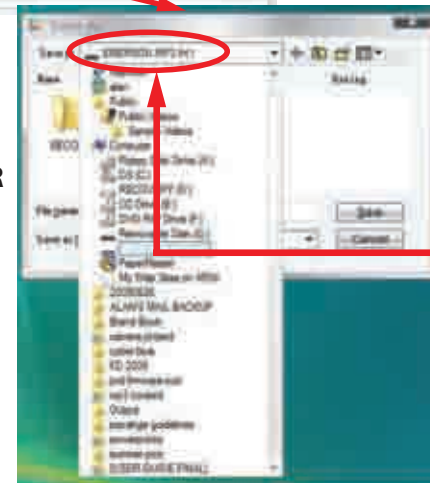

## Converting videos

9. Select the name for the file and click **"Save"**.
10. Click on the **"Fast configurator"** drop down window, and choose the image quality of the new video. High quality will use more memory and the output file will be bigger.
11. Click **"Convert"** to start the job queue. If more than one job is present they will be performed sequentially.
12. Once finished, click on **"OK"**, and exit the application.
13. Copy the new converted video file to your player. See **"TRANSFERRING MEDIA FILES TO THE PLAYER"** (page 11).

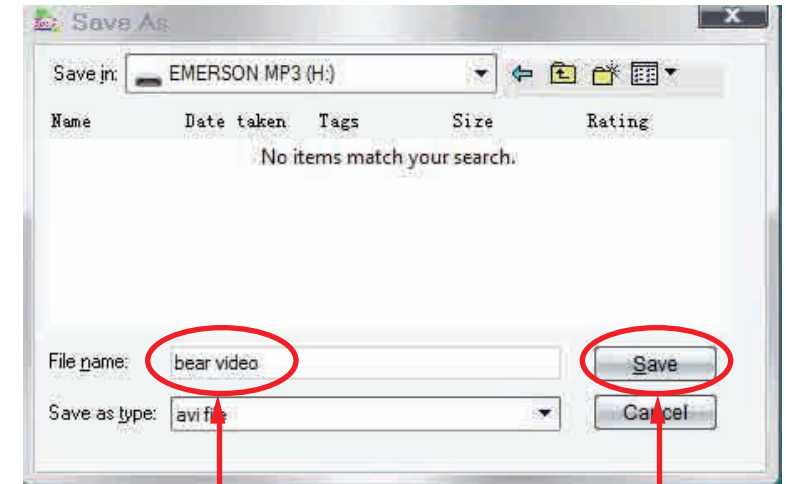

Select the name

Click **"Save"**

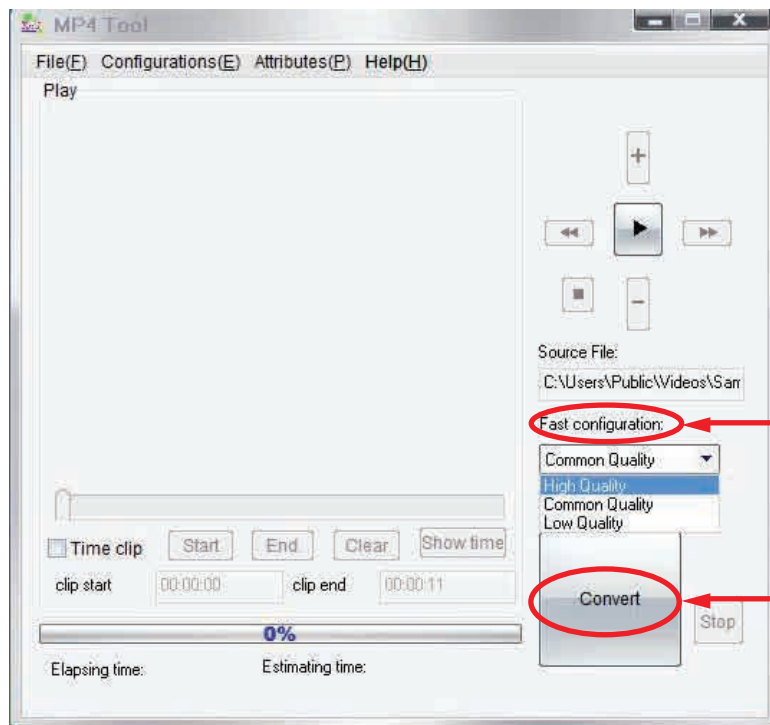

Click **"Fast configurator"** and choose the image quality

Click **"Convert"**

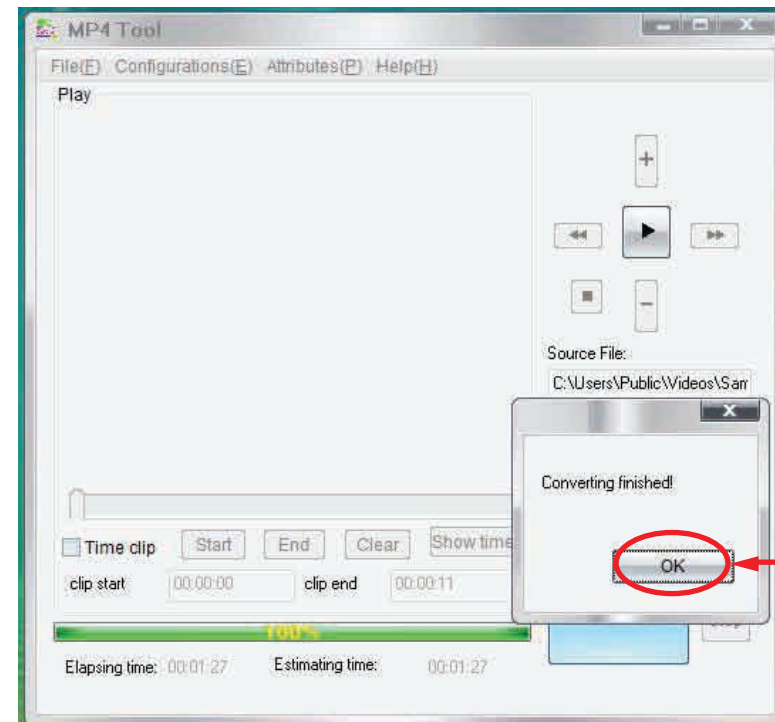

Click **"OK"**

## PHOTO

The **MP3 Video Player** is capable of storing and displaying your favorite pictures.

### Downloading pictures to the player

To download pictures from your computer, perform the following steps:

1. Connect the MP3 player to the USB port of your computer.
2. Open “**Windows Explorer**” or “**My Computer**”, and locate “**Emerson MP3**”.
3. Select the files on your computer, and simply move it into “**Emerson MP3**” in the usual way (drag-and-drop, copy-and-paste). After copying is completed, the data will be available on the MP3 player.

*We recommend using **Windows Media Player** to organize and transfer music and pictures to your player. For more information regarding **Windows Media Player**, please refer to the **Quick Start Guide**.*

***Note:** Please do not disconnect the USB cable during loading, it may cause malfunction of the player and the files.*

### Viewing pictures

1. Select “**PHOTO**” from the main menu using the [◀◀] or [▶▶] buttons, and press the [M] button to enter.
2. Use the [◀◀] or [▶▶] buttons to select the picture you wish to view, and press the [▶||] button.
3. Use the [◀◀] or [▶▶] buttons to skip to the previous or next picture.
4. Press the [M] button to enter the Photo options screen.
5. To return to the main menu, press and **HOLD** the [M] button.

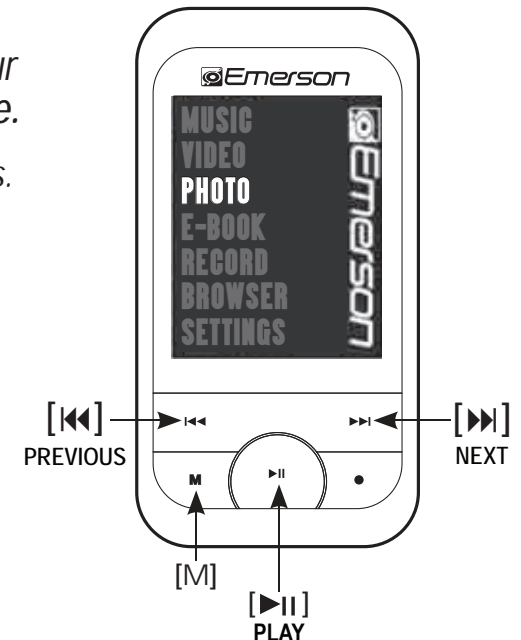
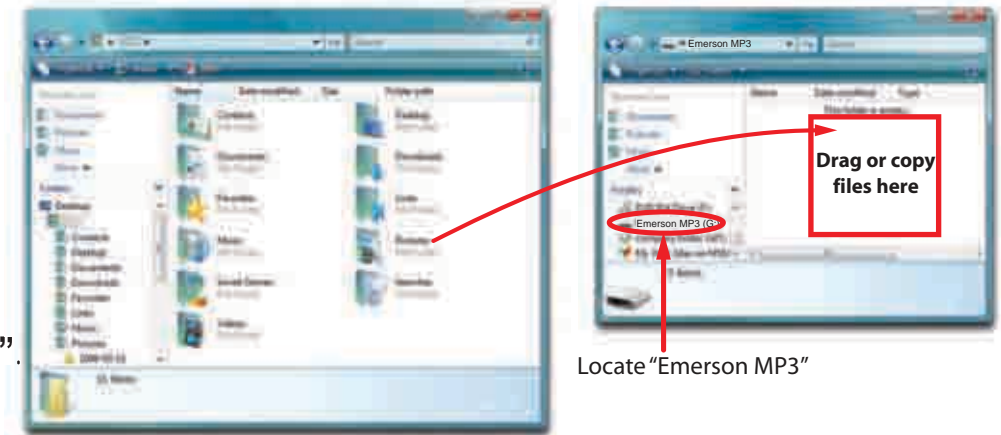

---

## E-BOOK

### Viewing TXT files

1. Select "E-BOOK" from the main menu using the [◀◀] or [▶▶] buttons, and press the [M] button to enter.
2. Use the [◀◀] or [▶▶] buttons to select the TXT file you wish to view, and press the [▶||] button.
3. Use the [◀◀] or [▶▶] buttons to skip to the next or previous page.
4. To set bookmarks press the [M] button while reading the E-bbok.
5. While reading the E-book, press the [▶||] button or press and **HOLD** the [M] button to return to the file list.
6. To return to the main menu, press and **HOLD** the [M] button again.

***NOTE:** The bookmark is only available to the current file, and has to be reset while reading the other files.*

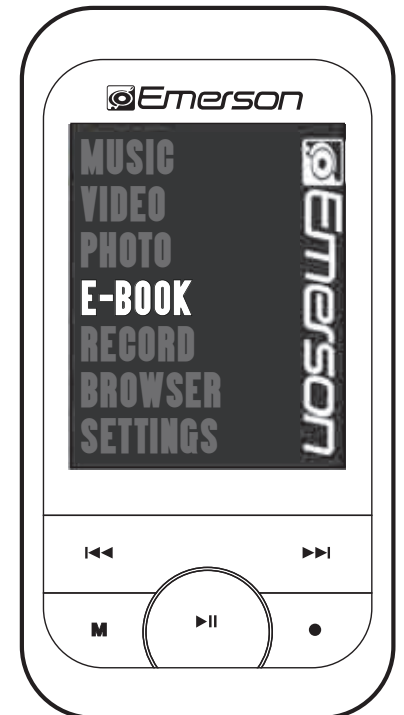

---

## RECORD

Your MP3 Player is able to perform voice recording with its integrated microphone.

Follow the steps below for voice recordings.

### Recording

1. Select “RECORD” from the main menu using the [◀◀] or [▶▶] buttons, and press the [M] button to enter.
2. Press the [▶||] button to begin recording, and press the [▶||] button again to pause recording.
3. Press and **HOLD** the [M] button to stop recording, save the recorded file, and return to the main menu.

### Playing back recorded files

1. Select “MUSIC” or “BROWSER” from the main menu using the [◀◀] or [▶▶] buttons, and press the [M] button to enter.
2. Use the [◀◀] or [▶▶] buttons and select the “Record” folder, and press the [M] button to enter.
3. Select the file you wish to play using the [◀◀] or [▶▶] buttons, and press the [M] or [▶||] button to begin playback.
4. Press the [▶||] button to pause or resume playback.
5. To return to the main menu, press and **HOLD** the [M] button.

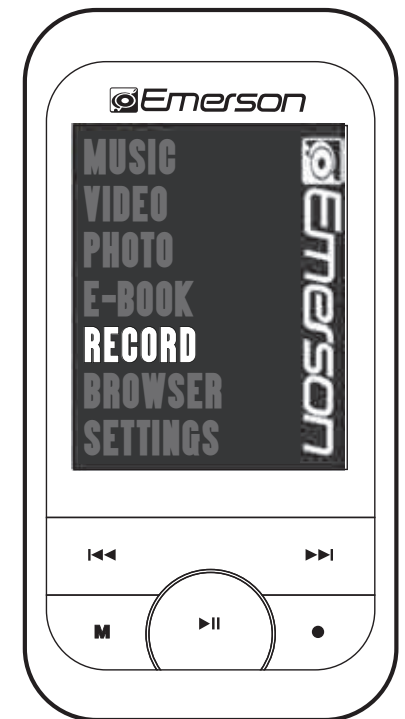

---

## BROWSER

Use the “**BROWSER**” feature to view all the files or folders list on your player.

1. Select “**BROWSER**” from the main menu using the [◀◀] or [▶▶] buttons, and press the [M] button to enter.
2. Use the [◀◀] or [▶▶] buttons to select the previous or next folder or file, and press the [M] button to enter the selected folder, or play the selected file.

### Deleting Files

#### ● From the player

1. Press the [▶||] button to pause the music or video (for pictures or e-book files skip to step 2).
2. Press the [M] button and select “**Delete file**”, or “**Delete All**”.
3. Use the [◀◀] or [▶▶], and [M] buttons to select and confirm.

### OR

#### ● From your computer

You can easily delete music, picture or video files by connecting your video player to the computer and selecting “**Emerson MP3**” from Windows Explorer or “**My Computer**”, or click on “**Open Folder**” to view files from the “**Auto play**” option window, simply select the file and delete it as you would delete any other file from your computer.

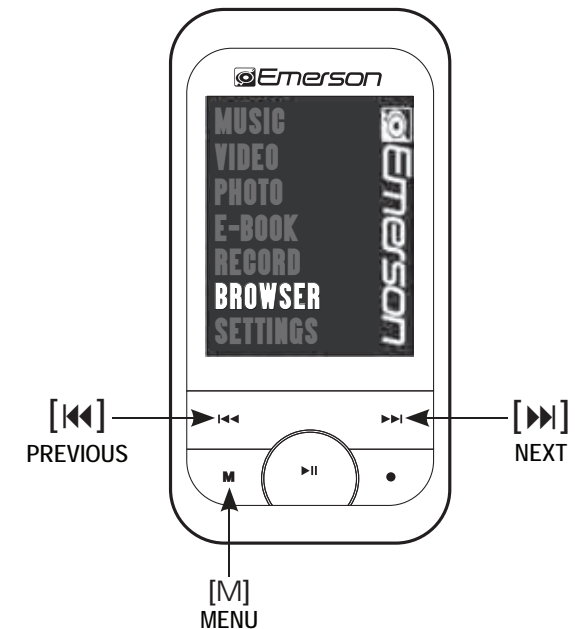

---

## SETTINGS

The player's settings can be customized by accessing "SETTINGS" in the main menu. The settings menu consists of several items where various functions can be selected concerning power, language, display, system, etc.

### Navigating the settings menu

1. Select "SETTINGS" from the main menu using the [◀◀] or [▶▶] buttons, and press the [M] button to enter.
2. Use the [◀◀] or [▶▶] buttons to select a settings options.
3. Press the [M] button to enter.
4. To save an option, use the [◀◀] or [▶▶] buttons to select the option, and press the [M] button to confirm.
5. To return to the previous screen, press the [▶||] button.
6. To return to the main menu, press and **HOLD** the [M] button.

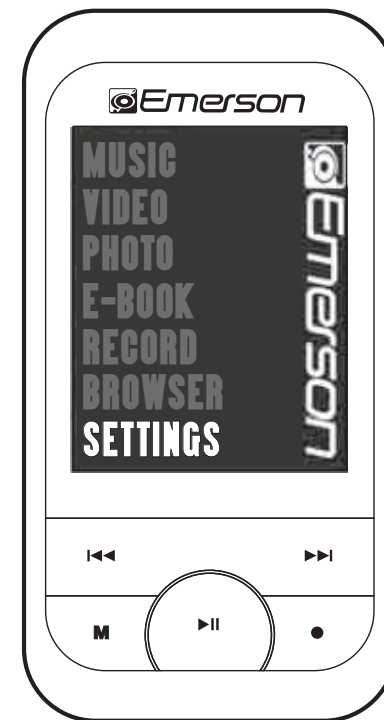



---

## TROUBLESHOOTING

If you have problems while operating your player, please check the points below before sending it to the service center.

### Can not power on

- The battery may be exhausted, please recharge the battery.

### Files can not be downloaded

- Check the connection between the player and PC.

### No sound from the headphones

- Please ensure the volume is turned up, and the headphones are properly connected.
- Check if the format of music file is supported by the player.

### Can not record

- Check if there is enough memory and battery capacity.

### Display is in the wrong language

- Please ensure you selected the correct language from the “**SETTINGS**” menu.

### My computer is not detecting the MP3 Video Player with Windows Vista

- There is a USB mass storage devices recognition issue with Windows Vista acknowledged by Microsoft. A solution is available in the Service Pack 1 which may be downloaded from Microsoft’s website.

### I cannot display my .jpg files

- Many digital cameras and image editing software add hidden data to the .jpg files. This data can prevent your MP3 from loading the images. Try to eliminate them by saving the file with another name.

### Player freezes or is not functioning properly

- Press the [Reset] button on the back of MP3 player using the tip of a paper clip or pin.

***NOTE:** Pressing the [Reset] button will not affect the files stored on the player.*

## SPECIFICATIONS

Display	1.5 inch color LCD	
Connect with PC	USB 2.0 (HIGH SPEED)	
Built-in memory	2GB	
Power source	Built-in Lithium battery	
Recording	Sampling rate	8 KHz/16KHz
	Recording format	WAV (32Kbps/64Kbps)
	Recording time	8 hours (128M Flash)
MP3, WMA	Earphone Max output	(L) 5mW+ (R) 5mW (32ohm)
	MP3 bit rate	8Kbps - 320Kbps
	WMA bit rate	32Kbps - 384Kbps
	Frequency response	20Hz to 20KHz
Music file format	MP1, MP2, MP3, WMA, WAV	
Video file format	AVI	
Operating temperature	-5 - 40° C	
Language	English, Spanish, German, French, Italian, Portugese.	
OS	SE/ME/2000/XP	

---

 **LIMITED WARRANTY**

In the unlikely event that this product is defective, or does not perform properly, you may within ninety (90) days from your original date of purchase return it to the authorized service center for repair or exchange.

**TO OBTAIN WARRANTY SERVICE:**

- Provide proof of the date of purchase within the package (Dated bill of sale)
- Prepay all shipping costs to the authorized service center, and remember to insure your return.
- Include a return shipping address (no P.O. Boxes), a telephone contact number, and the defective unit within the package.
- Describe the defect or reason you are returning the product.

Your product will be repaired or replaced, at our option, for the same or similar model of equal value if examination by the service center determines this product is defective. Products received damaged as a result of shipping, will require you to file a claim with the carrier.

---

The shipping address of the authorized service center is:



**Southern Telecom Inc.**  
**ATTN: Returns Department**  
**14-C 53rd Street**  
**Brooklyn, NY 11232**

Should you have any questions or problems concerning this product, please contact our customer service department at:



**1-877-768-8483 (Toll Free)**

**Monday - Thursday: 9AM - 5PM (EST)**

**Friday: 9AM - 3PM (EST)**

or

via e-mail at



**cs@southerntelecom.com**

---

To obtain service after the warranty period, please e-mail [cs@southerntelecom.com](mailto:cs@southerntelecom.com) with product information, date of purchase and nature of the problem. Customer service will reply to the e-mail with service instructions.

**Warranty service not provided:**

This warranty does not cover damage resulting from accident, misuse, abuse, improper installation or operation, lack of reasonable care, and unauthorized modification. This warranty is voided in the event any unauthorized person opens, alters or repairs this product. All products being returned to the authorized service center for repair must be suitably packaged.

**Limitation of Warranty:**

- THE WARRANTY STATED ABOVE IS THE ONLY WARRANTY APPLICABLE TO THIS PRODUCT. ALL OTHER WARRANTIES, EXPRESS OR IMPLIED (INCLUDING ALL IMPLIED WARRANTIES OF MERCHANTABILITY OR FITNESS FOR A PARTICULAR PURPOSE) ARE HEREBY DISCLAIMED. NO VERBAL OR WRITTEN INFORMATION GIVEN BY SOUTHERN TELECOM INC. IT'S AGENTS, OR EMPLOYEES SHALL CREATE A WARRANTY OR IN ANY WAY INCREASE THE SCOPE OF THIS WARRANTY.

---

- REPAIR OR REPLACEMENT AS PROVIDED UNDER THIS WARRANTY IS THE EXCLUSIVE REMEDY OF THE CONSUMER, SOUTHERN TELECOM INC. SHALL NOT BE LIABLE FOR INCIDENTAL OR CONSEQUENTIAL DAMAGES RESULTING FROM THE USE OF THIS PRODUCT OR ARISING OUT OF ANY BREACH OF ANY EXPRESS OR IMPLIED WARRANTY ON THIS PRODUCT. THIS DISCLAIMER OF WARRANTIES AND LIMITED WARRANTY ARE GOVERNED BY THE LAWS OF THE STATE OF NEW YORK. EXCEPT TO THE EXTENT PROHIBITED BY APPLICABLE LAW, ANY IMPLIED WARRANTY OF MERCHANTABILITY OR FITNESS FOR A PARTICULAR PURPOSE ON THIS PRODUCT IS LIMITED TO THE APPLICABLE WARRANTY PERIOD SET FORTH ABOVE.

**How state law relates to this warranty:**

- Some states do not allow the exclusion nor limitation of incidental, consequential damages, or limitations on how long an implied warranty lasts so the above limitations or exclusion may not apply to you..
- This warranty gives you specific legal rights, and you also may have other rights that vary from state to state.



Manufactured by: AIT Inc. Brooklyn, NY 11232

Emerson and the G-Clef logo are registered trademarks of Emerson Radio Corp. Parsippany, New Jersey USA

© 2009 AIT Inc. All rights reserved

Microsoft, the Windows logo, and Windows Media are either registered trademarks of Microsoft Corporation  
in the United States and / or other countries.

---